

C35

CONCEALED SINGLE LEVER 3 OUTLETS EUR

Ref. C35.0053

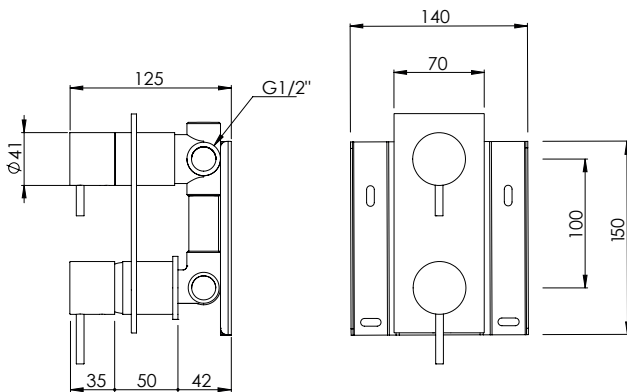

QUALITY

All products are 100% checked during the packaging process, ensuring their tightness and functionality.

Product may not be altered!

May not be used for hot water application exceeding 70°C

PRODUCT DETAILS



CLEANING & MAINTENANCE

Please only use cleaning products that do not contain any solvents and are acid-free.

Clean the surfaces using a soft cloth soaked in liquid soap diluted in water, then rinse and dry thoroughly.

For stainless steel use products specifically for stainless steel. Never use abrasive sponges, metal wool or detergents containing abrasive substances.

Caution! The use of products other than those recommended may damage the surfaces irreparably, in which case the manufacturer will not be held liable.

AVAILABLE FINISHES



C35

**CONCEALED SINGLE LEVER 3
OUTLETS EUR**

Ref. C35.0053.PEX

Unavailable

C35

**CONCEALED SINGLE LEVER 3
OUTLETS EUR**

Ref. C35.0053.PIT

Unavailable

C35

CONCEALED SINGLE LEVER 3 OUTLETS EUR

Ref. C35.0053

5 YEARS WARRANTY

We believe in the quality and durability of our products, which is why we voluntarily offer an extension to a 5-year warranty.

General Information

HAPA, a brand that is under warranty from the taps supplier MCT group (Metalúrgica Central da Trofa, Lda), provides its customers with a manufacturer's warranty on all its products.

For the purposes of this Manufacturer Warranty, a "Consumer" is any natural person or legal entity who is the owner of the product and has not acquired it with a view to reselling it or installing it at third parties in the course of commercial or independent professional activity. Additionally, we consider "Initial Customer", who was the first to purchase Hapa brand products, a dealer or any other natural or legal person, who resells or installs the product in the course of their commercial or independent professional activity.

Warranty period

The period of warranty starts on the date on which the Initial Customer who wishes to claim under the warranty has purchased a HAPA brand product. The date of purchase must be proved by the original invoice. It is essential that the original invoice shows the date of purchase.

This warranty applies to all HAPA brands products for a period of 5 years from the date of purchase as shown by the original invoice.

How to trigger a warranty claim?

The rights under this warranty can be asserted by the Consumer within the warranty period by written notification of defects against HAPA or the dealer from whom the Initial Consumer purchased the product. It's mandatory that the Consumer prove with the aid of the original receipt that the warranty has not expired.

The prerequisite for the validity of this warranty is professional installation and maintenance. This includes, but is not limited to, ensuring that the inlet water pipes are properly flushed in accordance with the applicable standards, especially before product installation or after construction work.

The warranty claim does not cover:

- wearing parts such as seals, O-rings, soap dispenser pumps, due to wear and tear;
- damage caused by improper installation;
- products installed in environments with a high chlorine content, like swimming pools;
- display products;
- consumables such as batteries, filters or aerators, due to consumption;
- injections of dirt, water hammer, especially hot water hammer, limescale deposits, operating and handling errors damage due to aggressive environmental influences, chemicals, cleaning agents;

The validity of the warranty ends:

- in the event of damage caused by force majeure or natural disasters, in particular but not exclusively floods, fires or frost damage;
- for products that have not been used or are not being used in accordance with their intended purpose;
- in the event of non-compliance with the instructions for assembly, care and use supplied;
- if the installation, maintenance and repair or care has not been carried out by a specialist;
- in the event of product damage caused by the seller, installer or third parties;
- if the damage is caused by negligence, contributory negligence;
- in the event of inadequate or faulty maintenance;

Non-applicability of the warranty

If it turns out that a product defect is not covered by this warranty, the costs incurred for dispatch and transport of the product must be borne by the Consumer. In addition, the Consumer must bear the costs, including any labour costs, incurred in investigating the products and the costs of dismantling and reinstalling the product. Where the Consumer has been informed that the warranty does not apply but still wishes the repair to go ahead, the Consumer must bear the additional costs for the spare parts and labour costs.

Final provisions

This warranty applied to any future owner of the product who is a Consumer to the extent and subject to the conditions set out above. This warranty is subject to the law of PORTUGAL.